

# POP Bolt™

Rapid Fastening System



Edition 04 2012

[emhart.eu](http://emhart.eu)

**EMHART**  
TEKNOLOGIES

# Expertise in Fastening Solutions

With over 100 years experience in the design and manufacture of assembly technology, Emhart has the expertise to provide fastening solutions to a wide range of industries from Automotive, Construction, and Electronics through to sheet metal assembly and general industry.

We offer consulting, technical advice, a wide range of volume parts and high quality setting equipment to meet the varying needs of our customers.

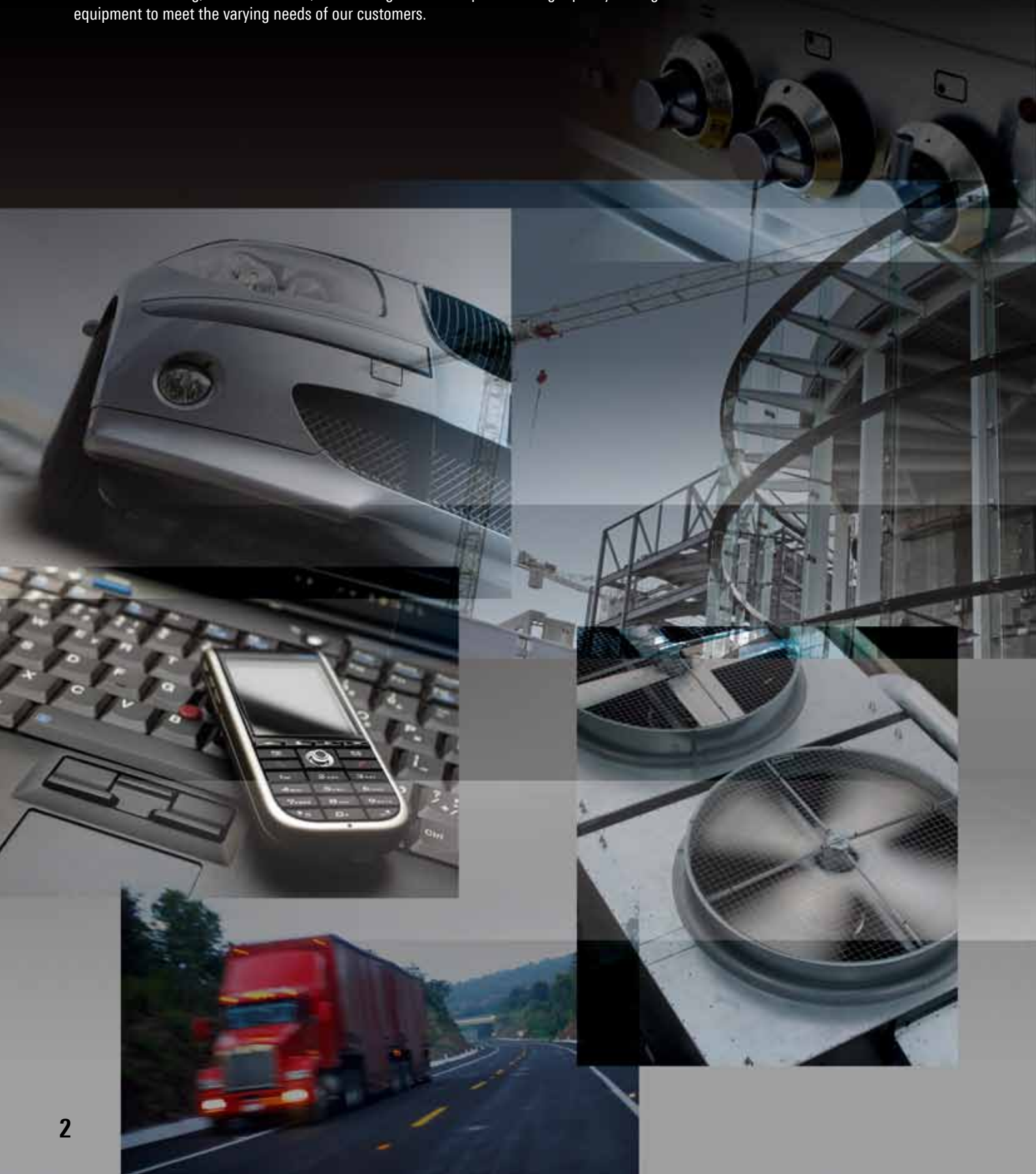

# Emhart in Europe

Emhart has experienced technical experts and application engineers available throughout Europe ready to support customers with application and assembly processes and fastener specifications.

We service our European customers directly through our manufacturing and warehousing facilities around Europe or through our network of highly experienced distributors.



- Emhart Facilities and Distribution Network
- Distribution Network

## POP Bolt™

POP Bolt™ is a rapid setting, removable and re-useable fastening system. Delivering the speed of riveting combined with the flexibility of a nut and bolt, POP Bolt™ is ideal for applications that require a high strength fastener that facilitates servicing.



## POP Bolt™ Twinfix

POP Bolt™ Twinfix has been developed specifically for the transport sector. The Twinfix carrier is designed to aid the fastening of buckles and rollers to truck curtains. The Twinfix allows for servicing and can be used in conjunction with Secureset to give a tamper resistant joint.



## POP Bolt™ Tools

The POP Bolt™ tool range includes a compact, lightweight pneumatic-hydraulic tool and a cordless, rechargeable battery tool.





## The POP Bolt™ rapid installation sequence is simple.

1. Place the bolt through the holes in the materials to be fastened and load the collar into the setting tool.
2. Position the tool and loaded collar over the bolt.
3. Pull the trigger of the setting tool. As the tool pulls the bolt mandrel the collar clamps down onto the threaded section of the bolt. The collar is swaged onto the bolt forming an internal thread, while the tool's nosepiece forms an external hex shape, transforming the collar into a nut.
4. The POP Bolt™ is now assembled.



## POP Bolt™ Features

### POP Bolt™

**POP Bolt™ is a rapid setting, removable and re-useable two piece, fastening system.**

POP Bolt™ combines the advantages in functionality achieved by a traditional nut and bolt with those of a conventional pin and collar fastener. Helical threads, formed during the setting process, allow removal and reuse of the POP Bolt's™ nut, while the swaging process results in a vibration resistant joint.

The POP Bolt™ installation process takes under one second, resulting in reduced assembly time.

### POP Bolt™ offers:

- **Up to a 60% reduction in process time when compared to traditional fastening methods, increasing productivity**
- Elimination of pre-assembly processes, increasing efficiency
- Rapid installation (setting in under a second), that reduces operator fatigue
- Elimination of cross threading, as the nut's thread is formed during the setting process
- Consistent clamp load after installation, independent of operator control, eradicating the need for torque control and process monitoring
- An easily removable and reusable and vibration resistant nut, that facilitates servicing of components
- Easily set with either a lightweight, pneumatic-hydraulic power tool or a cordless, rechargeable battery tool

### Ease of Assembly

With POP Bolt™ the collar is simply and quickly loaded into the setting tool.

The time consuming pre-assembly of nut and bolt, prior to tightening, is eliminated.



### Ease of Maintenance

The POP Bolt™ collar is easily removed with a conventional wrench, allowing for repair or maintenance work.

Once removed the collar can be reapplied with a torque value of up to 10 Nm.



### Typical Applications



Truck curtain buckles and rollers



Industrial lighting



Lighting elements



Castors



Scaffold

## Components and Installation

### POP Bolt™ system components

The diagram illustrates the components of the POP Bolt™ fastening system. After the non-threaded, flanged collar is loaded into the setting tool it is placed over the threaded section of the bolt. The jaws of the setting tool engage the non-threaded section of the bolt, which is known as the mandrel.

Once the jaws are engaged, they pull on the mandrel and force the collar into a hexagonal former located in the nosepiece of the tool.

The former forces the external collar into a hexagonal shape, while the swaging of the collar onto the bolt forms internal threads. The collar is transformed into a nut.

On completion the mandrel breaks at the crimp, and is ejected into the collector at the rear of the tool.

This process results in the creation of a serviceable, mechanical joint with a consistent clamp force.

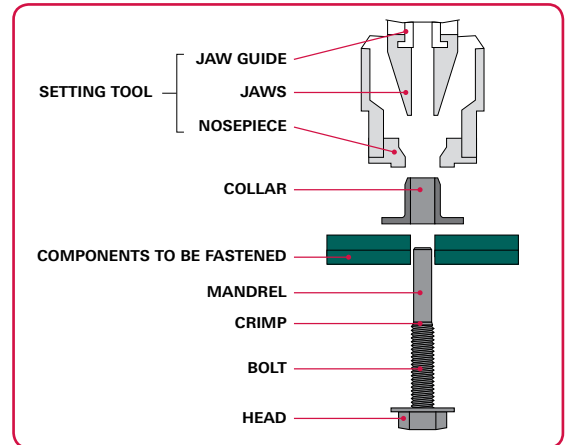

### Installation method

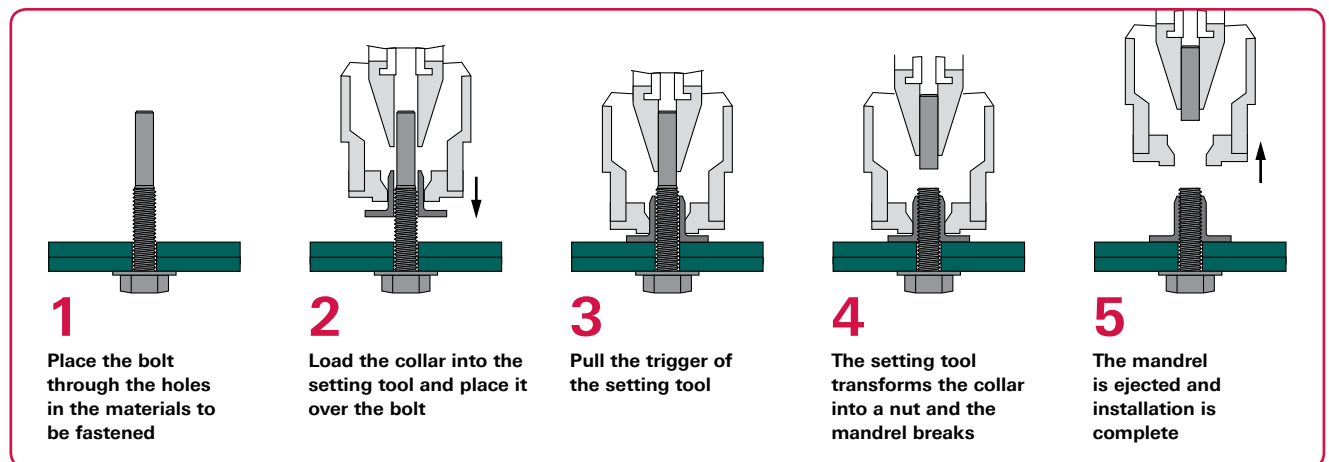

### Installation sequence curve

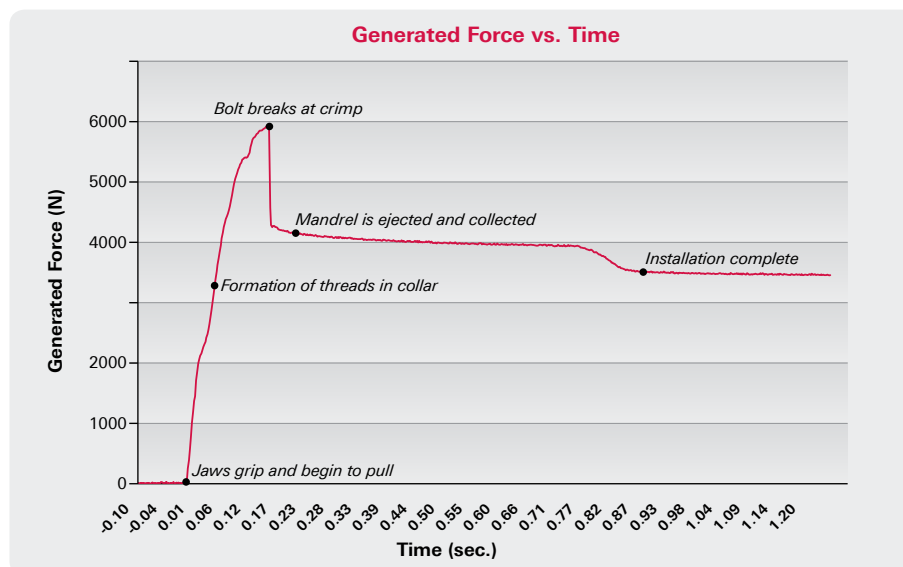

POP Bolt™ before setting



POP Bolt™ after setting

## POP Bolt™ Head and Collar Styles

### POP Bolt™ Head Styles

POP Bolt™ is available in standard head style configurations as seen below:



**Hex Washer Head**



**Slotted Truss Head**

### POP Bolt™ Collar Styles

POP Bolt™ collars are available as standard in steel and aluminium. (Stainless steel collars are available on request.)

During the setting process the nosepiece of the setting tool dictates the final shape the collar will have externally, once formed into a nut.

The two options are:



**Hex Set**

This hexagonal form is suitable for easy removal with a conventional wrench.



**Secureset**





This rounded form offers excellent tamper resistance and can be removed with a reverse spiral fluted socket. Additional benefits of Secureset are improved vibration resistance and a higher tensile yield.

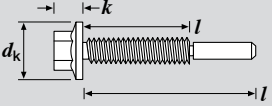

## Hex Washer Head Bolt

8.8 Grade Steel







THREAD SIZE	DESCRIPTION						 /1,000	ARTICLE	BOX QTY	 PCS-6S HEX SET T'	 PCS-6S SECURESET T'
		mm	mm	mm	mm						
M6	PBS-HWH-8-M6X13	13.6	6.8	29	13	0-3.5	8.10	78908	500	7,000	10,000
	PBS-HWH-8-M6X16	13.6	6.8	32	16	1.5-6.5	8.66	78909	500	7,000	10,000
	PBS-HWH-8-M6X19	13.6	6.8	35	19	4.5-9.5	9.20	78910	500	7,000	10,000
	PBS-HWH-8-M6X22	13.6	6.8	38	22	7.5-12.5	9.74	78911	500	7,000	10,000
	PBS-HWH-8-M6X25	13.6	6.8	41	25	10.5-15.5	10.30	78912	500	7,000	10,000
	PBS-HWH-8-M6X28	13.6	6.8	44	28	13.5-18.5	10.84	78921	500	7,000	10,000
	PBS-HWH-8-M6X31	13.6	6.8	47	31	16.5-21.5	11.38	78922	500	7,000	10,000
	PBS-HWH-8-M6X34	13.6	6.8	50	34	19.5-24.5	11.93	78923	500	7,000	10,000
	PBS-HWH-8-M6X37	13.6	6.8	53	37	22.5-27.5	12.47	78924	500	7,000	10,000
	PBS-HWH-8-M6X40	13.6	6.8	56	40	25.5-30.5	13.02	78925	500	7,000	10,000

## Slotted Truss Head Bolt

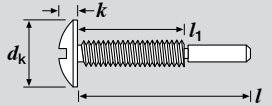

8.8 Grade Steel



THREAD SIZE	DESCRIPTION						 /1,000	ARTICLE	BOX QTY	 PCS-6S HEX SET T'	 PCS-6S SECURESET T'
		mm	mm	mm	mm						
M6	PBS-THS-8-M6X13	16	3.5	29	13	0-3.5	7.03	78936	500	7,000	10,000
	PBS-THS-8-M6X16	16	3.5	32	16	1.5-6.5	7.58	78937	500	7,000	10,000
	PBS-THS-8-M6X19	16	3.5	35	19	4.5-9.5	8.13	78938	500	7,000	10,000
	PBS-THS-8-M6X22	16	3.5	38	22	7.5-12.5	8.68	78939	500	7,000	10,000
	PBS-THS-8-M6X25	16	3.5	41	25	10.5-15.5	9.22	78940	500	7,000	10,000
	PBS-THS-8-M6X28	16	3.5	44	28	13.5-18.5	9.76	78941	500	7,000	10,000
	PBS-THS-8-M6X31	16	3.5	47	31	16.5-21.5	10.31	78942	500	7,000	10,000
	PBS-THS-8-M6X34	16	3.5	50	34	19.5-24.5	10.86	78943	500	7,000	10,000
	PBS-THS-8-M6X37	16	3.5	53	37	22.5-27.5	11.40	78944	500	7,000	10,000
	PBS-THS-8-M6X40	16	3.5	56	40	25.5-30.5	11.95	78945	500	7,000	10,000

## Collars

For Steel Bolts

SIZE	MATERIAL	DESCRIPTION	 df mm	 l mm	 /1,000	ARTICLE	BOX QTY
6mm	Steel	PCS-6S	16	10.25	4.50	78904	500

dk=Head Diameter; df=Flange Diameter; k=Head Thickness; l=Length; l1=Thread Length; g=Grip Range (Min - Max); T'=Tensile Strength

## Hex Washer Head Bolt

A2 Grade Stainless Steel



THREAD SIZE	DESCRIPTION	Dimensions				g	KG /1,000	ARTICLE	BOX QTY	PCS-6S		PCA-6S	
		$d_k$	$k$	$l$	$l_1$					HEX SET T	SECURESET T	HEX SET T	SECURESET T
		mm	mm	mm	mm	mm	kg			N	N	N	N
M6	PBSS-HWH-A2-M6X13	13.6	6.8	29	13	0-3.5	8.10	78983	500	7,000	10,000	5,700	9,000
	PBSS-HWH-A2-M6X16	13.6	6.8	32	16	1.5-6.5	8.66	78984	500	7,000	10,000	5,700	9,000
	PBSS-HWH-A2-M6X19	13.6	6.8	35	19	4.5-9.5	9.20	78985	500	7,000	10,000	5,700	9,000
	PBSS-HWH-A2-M6X22	13.6	6.8	38	22	7.5-12.5	9.74	78986	500	7,000	10,000	5,700	9,000
	PBSS-HWH-A2-M6X25	13.6	6.8	41	25	10.5-15.5	10.30	78987	500	7,000	10,000	5,700	9,000
	PBSS-HWH-A2-M6X28	13.6	6.8	44	28	13.5-18.5	10.84	78988	500	7,000	10,000	5,700	9,000
	PBSS-HWH-A2-M6X31	13.6	6.8	47	31	16.5-21.5	11.38	78989	500	7,000	10,000	5,700	9,000
	PBSS-HWH-A2-M6X34	13.6	6.8	50	34	19.5-24.5	11.93	78990	500	7,000	10,000	5,700	9,000
	PBSS-HWH-A2-M6X37	13.6	6.8	53	37	22.5-27.5	12.47	78991	500	7,000	10,000	5,700	9,000
	PBSS-HWH-A2-M6X40	13.6	6.8	56	40	25.5-30.5	13.02	78992	500	7,000	10,000	5,700	9,000

## Slotted Truss Head Bolt

A2 Grade Stainless Steel



THREAD SIZE	DESCRIPTION	Dimensions				g	KG /1,000	ARTICLE	BOX QTY T	PCS-6S		PCA-6S	
		$d_k$	$k$	$l$	$l_1$					HEX SET T	SECURESET T	HEX SET T	SECURESET T
		mm	mm	mm	mm	mm	kg			N	N	N	N
M6	PBSS-THS-A2-M6X13	16	3.5	29	13	0-3.5	7.03	79012	500	7,000	10,000	5,700	9,000
	PBSS-THS-A2-M6X16	16	3.5	32	16	1.5-6.5	7.58	79013	500	7,000	10,000	5,700	9,000
	PBSS-THS-A2-M6X19	16	3.5	35	19	4.5-9.5	8.13	79014	500	7,000	10,000	5,700	9,000
	PBSS-THS-A2-M6X22	16	3.5	38	22	7.5-12.5	8.68	79015	500	7,000	10,000	5,700	9,000
	PBSS-THS-A2-M6X25	16	3.5	41	25	10.5-15.5	9.22	79016	500	7,000	10,000	5,700	9,000
	PBSS-THS-A2-M6X28	16	3.5	44	28	13.5-18.5	9.76	79017	500	7,000	10,000	5,700	9,000
	PBSS-THS-A2-M6X31	16	3.5	47	31	16.5-21.5	10.31	79018	500	7,000	10,000	5,700	9,000
	PBSS-THS-A2-M6X34	16	3.5	50	34	19.5-24.5	10.86	79019	500	7,000	10,000	5,700	9,000
	PBSS-THS-A2-M6X37	16	3.5	53	37	22.5-27.5	11.40	79020	500	7,000	10,000	5,700	9,000
	PBSS-THS-A2-M6X40	16	3.5	56	40	25.5-30.5	11.95	79021	500	7,000	10,000	5,700	9,000

## Collars

For Stainless Steel Bolts

SIZE	MATERIAL	DESCRIPTION	$d_f$	T	KG /1,000	ARTICLE	BOX QTY
			mm	mm	kg		
6mm	Steel	PCS-6S	16	10.25	4.50	78904	500
6mm	Aluminium	PCA-6S	16	10.25	1.61	79034	500

Stainless Steel collars available on request.

$d_k$ =Head Diameter;  $d_f$ =Flange Diameter;  $k$ =Head Thickness;  $l$ =Length;  $l_1$ =Thread Length;  $g$ =Grip Range (Min - Max);  $T$ =Tensile Strength

## Twifix with Hex Head Bolt

A2 Grade Stainless Steel



THREAD SIZE	DESCRIPTION	Length		Grip Range <i>g</i>	Weight /1,000	ARTICLE	BOX QTY	PCS-6S SECURESET		PCA-6S SECURESET	
		<i>l</i>	<i>l</i> <sub>1</sub>					HEX SET <i>T</i>	SECURESET <i>T</i>	HEX SET <i>T</i>	SECURESET <i>T</i>
		mm	mm	mm	kg			N	N	N	N
<b>M6</b>	PBSS-TFX-A2-M6X13	29	13	0-3.5	13.71	79170	250	7,000	10,000	5,700	9,000
	PBSS-TFX-A2-M6X16	32	16	1.5-6.5	14.27	79171	250	7,000	10,000	5,700	9,000
	PBSS-TFX-A2-M6X19	35	19	4.5-9.5	14.81	79172	250	7,000	10,000	5,700	9,000
	PBSS-TFX-A2-M6X22	38	22	7.5-12.5	15.35	79173	250	7,000	10,000	5,700	9,000
	PBSS-TFX-A2-M6X25	41	25	10.5-15.5	15.91	79174	250	7,000	10,000	5,700	9,000
	PBSS-TFX-A2-M6X28	44	28	13.5-18.5	16.45	79175	250	7,000	10,000	5,700	9,000
	PBSS-TFX-A2-M6X31	47	31	16.5-21.5	16.99	79176	250	7,000	10,000	5,700	9,000
	PBSS-TFX-A2-M6X34	50	34	19.5-24.5	17.54	79177	250	7,000	10,000	5,700	9,000
PBSS-TFX-A2-M6X37	53	37	22.5-27.5	18.08	79178	250	7,000	10,000	5,700	9,000	

## Carrier Dimensions

Nylon 6

WIDTH <i>w</i>	LENGTH <i>l</i>	HOLE CENTRES <i>h</i>	DEPTH <i>d</i>
mm	mm	mm	mm
25	53	28.5	6

## Collars

For Stainless Steel Bolts

SIZE	MATERIAL	DESCRIPTION	<i>d</i> <sub>f</sub>	<i>l</i>	Weight /1,000	ARTICLE	BOX QTY
			mm	mm	mm	mm	kg
6mm	Steel	PCS-6S	16	10.25	4.50	78904	500
6mm	Aluminium	PCA-6S	16	10.25	1.61	79034	500

Stainless Steel collars available on request.

## The Twifix installation method



*l*=Length; *l*<sub>1</sub>=Thread Length; *g*=Grip Range (Min - Max); *T*=Tensile Strength; *W*=Width; *h*=Hole Centres; *d*=Depth; *d*<sub>f</sub>=Flange Diameter

## POP Bolt™ Power Tool

### ProSet® PSL2500CJ-HEX

The ProSet® range of power tools sets a new standard for pneumatic setting tools.

This POP Bolt™ setting tool is compact and lightweight, and features an integrated bolt release mechanism.

#### Features & Benefits:

- Lightweight aluminium and polymer construction
- Comfortable two finger, low activation force trigger
- Left or right swivel air fitting
- Airless mandrel collection system (MCS) to reduce air consumption
- Integrated bolt release mechanism
- Secureset nosepiece compatible



Mandrel Collection System (MCS)



PSL2500CJ-HEX  
Article Number: 19661

#### Specifications

Weight	1.31 kg
Length	324 mm
Height	259 mm
Tool stroke	18 mm
Working air pressure	5.0 - 6.9 bar
Pulling force	9400 N @ 6.2 bar
Force/Weight ratio	7.18 kN/kg
Air consumption	70 litres/min (max)

### MCS5800-HEX

#### Cordless, rechargeable battery tool.

This portable POP Bolt™ tool is ideal for site, automotive and maintenance work, or in instances that compressed air is not available.

#### Features & Benefits:

- Instant return to start position on release of trigger
- Up to 500 settings with one charge
- Integral Mandrel Collection System
- Supplied in durable metal case, including tool, battery and charger
- Charging time approx. 1 hour

#### Specifications

Weight	2.2 kg
Length	265 mm
Height	300 mm
Tool stroke	20 mm



**MCS5800-HEX**  
Article Number: 17501

### Secureset

The Secureset nosepiece is available for use in both POP Bolt™ tools.

Installation of either the Hex or Secureset nosepiece in both POP Bolt™ tools takes a matter of minutes.

Secureset gives a rounded form to the assembled POP Bolt™ nut, for tamper resistance.

A Secureset nut is removable using a reverse spiral fluted socket.



**Secureset Nosepiece**  
Article Number: 79180







## EUROPE

**United Kingdom**  
**Emhart Teknologies**  
Tucker Fasteners  
177 Walsall Road  
Birmingham, B42 1BP  
United Kingdom  
Tel: +44 121 356 4811  
Fax: +44 121 356 1598  
csduk@bdk.com

**The Netherlands**  
**Emhart Teknologies**  
P.O. Box 514  
6190 BA Beek  
Europalaan 12  
6199 AB Maastricht-Airport  
The Netherlands  
Tel: +31 43 750 2020  
Fax: +31 43 750 2030

**Spain**  
**Emhart Teknologies**  
Sistemas de Fijacion Tucker  
Carretera M-300  
KM. 29,700  
28802 Alcalá de Henares  
Madrid, Spain  
Tel: +34 91 887 1470  
Fax: +34 91 882 3602  
sft.pedidos@bdk.com

**France**  
**Emhart Teknologies**  
Emhart SNC  
Zone Immoparc  
Route de Chartres, Bât Loire 4  
78190 TRAPPES  
France  
Tel: +33 1 30 50 91 00  
Fax: +33 1 30 51 07 08  
csdfr@bdk.com

**Germany**  
**Emhart Teknologies**  
Tucker Fasteners GmbH  
Max-Eyth-Strasse 1  
D-35394 Giessen  
Germany  
Tel: +49 641 405 0  
Fax: +49 641 405 366  
pop.de@bdk.com

**Norway**  
**Emhart Teknologies**  
Emhart Sjong  
PO Box 203  
Skjutbanevägen 6  
S-701 44 Örebro  
Sweden  
Tel: +47 22 90 99 90  
Fax: +46 19 26 00 38  
info@emhart-teknik.se

**Denmark**  
**Emhart Teknologies**  
Emhart Harttung A/S  
Farverland 1B  
DK-2600 Glostrup  
Denmark  
Tel: +45 44 84 11 00  
Fax: +45 44 84 62 12  
salg.danmark@bdk.com

**Sweden**  
**Emhart Teknologies**  
Emhart Teknik AB  
PO Box 203  
Skjutbanevägen 6  
S-701 44 Örebro  
Sweden  
Tel: +46 19 20 58 00  
Fax: +46 19 26 00 38  
info@emhart-teknik.se

**Finland**  
**Emhart Teknologies**  
Emhart Finland  
Hyttimestarinkuja 4 PL 25  
FI-02781 Espoo  
Finland  
Tel: +358 9 819 0060  
Fax: +358 9 812 428  
myynti.emhart@bdk.com

**Czech Republic**  
**Emhart Teknologies**  
Tucker s.r.o.  
Tel: +420 725 800 454  
Fax: +420 493 546 567

**Poland**  
**Emhart Teknologies**  
Masterfix Poland LTD  
ul. Daleka 16  
60-124 Poznań, Poland  
Tel: +48 61 86 66 297  
Fax: +48 61 86 65 733

## AMERICAS

**USA - Connecticut**  
**Emhart Teknologies**  
4 Corporate Drive, Suite 395  
Shelton, CT 06484  
USA  
Tel: +1 203 925 2260  
Fax: +1 203 925 2279

**Canada**  
**Emhart Teknologies**  
9870 Boulevard Du Golf  
Anjou, Quebec  
Canada H1J 2Y7  
Tel: +1 514 351 0330  
Fax: +1 514 351 0458

**Mexico**  
**Emhart Teknologies**  
Bosque De Cidros  
Acceso Radiatas No 42  
Bosque De Las Lomas,  
3a Seccion, Mexico City  
Mexico DF 05120  
Tel: +52 55 5326 7100  
Fax: +52 55 5236 7141

**Brazil**  
**Emhart Teknologies**  
Emhart Refal  
Rua Ricardo Cavatton, 226  
CEP: 05038-110 São Paulo  
Brazil  
Tel: +52 55 11 3871 6460  
Fax: +52 55 11 3611 3505

## ASIA

**China**  
**Emhart Teknologies**  
Shanghai Emhart Fastening  
Systems  
488 Jialou Road  
Jaiding District  
Shanghai 201807, China  
Tel: +86 21 5954 8626  
Fax: +86 21 5954 8775

**Japan**  
**Emhart Teknologies**  
Shuwa Kioicho Park Building 302  
3-6 Kioicho, Chiyoa-Ku  
Tokyo, 1020094, Japan  
Tel: +81 3 3265 7291  
Fax: +81 3 3265 7298

**Korea**  
**Emhart Teknologies**  
Seorin Building  
45-15 Yeoido-Dong  
Yeongdeungpo-Ku  
Seoul, 150-891, R.O. Korea  
Tel: +82 2 783 9226  
Fax: +82 2 783 9228

**India**  
**Emhart Teknologies**  
APEX Towers, 5th Floor  
No 54, 2nd Main Road  
R.A. Puram, Chennai- 600028  
India  
Tel: +91 44 4306 0639  
Fax: +91 44 4306 0768

© Emhart Teknologies 2012

The latest version of this catalogue is available to view and download at [www.emhart.eu](http://www.emhart.eu)

POP®, POPSet®, ProSet®, Point&Set®, POPNut® and Tucker® are registered trademarks of Emhart Teknologies.  
SmartSet™ and POP Bolt™ are trademarks of Emhart Teknologies.

Quality systems approvals from the world's household names in manufacturing serve to reinforce accreditation to ISO14001 / ISO9001 / TS16949.

As a result of our continuous design improvement, Emhart products are subject to modification. The latest technical data and drawings are available for any specific products on request.